



Boundary

A double-sided modular upholstery system



Product Description

Boundary is a modular upholstery system whose simple components can either be used individually or linked to provide multiple scenarios. The double-sided modular system is the perfect solution when mid-floor furniture is required to effectively divide the space and provide dense yet flexible multiple seating positions.

The upholstery seating modules can be combined with an infill upholstered linking unit, which can be specified to provide power and data at seat level, and a pivoting worktable.

When specified with the single cast aluminium leg, Boundary becomes a companion product to Perimeter, with which it shares many component and dimensional attributes. It can also be specified with a tubular steel leg, with both leg options being available in our standard metal finishes.





Product Range

BOUNDARY-01
4 seat unit

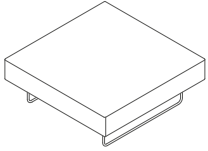

H460 [H18]
W1200 [W47] D1200 [D42]

BOUNDARY-01MM
4 seat unit, mid mount

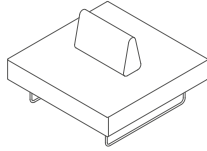

H820 [H32]
W1200 [W47] D1200 [D42]

BOUNDARY-01EM
4 seat unit, end mount

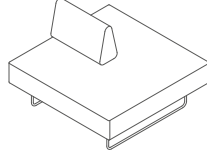

H820 [H32]
W1200 [W47] D1200 [D42]

BOUNDARY-01DB
4 seat unit, double back

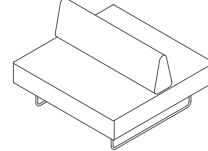

H820 [H32]
W1200 [W47] D1200 [D42]

BOUNDARY-06
90° unit

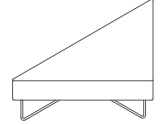

H460 [H18]
W1200 [W47] D1200 [D42]

BOUNDARY-07
D - end unit



H460 [H18]
W1200 [W47] D600 [D24]

BOUNDARY-08
Low arm unit

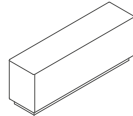

H460 [H18]
W1200 [W47] D300 [D12]

BOUNDARY-09
High arm unit

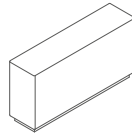

H460 [H18]
W1200 [W47] D300 [D12]

*Minimum recommended ceiling height 2550mm to accommodate pod and fan.



Product Specification

Standard Product Description

Tubular Legs: High tensil tubular steel finished in RAL 9006, Stone, Black or White.

Frame: Plywood and hardwood frame with glued and screwed joints.

Foam: Vitafoam Reflex and elasticated webbing.

Writing Tablet Support: RAL 9006 or Stone Table Support as standard. [08]

Table Top Finishes:

Melamine – Walnut, Grained Oak, Artisan Oak, Beech, Graphite, White or Grey.

Optional Upcharges

Tubular Legs: Chrome tubular legs available as an upcharge.

Landscape Legs: Finished in Polished, RAL 9006, Stone, Black or White.

Plinth: Finished in Chrome. [08 & 09]

Writing Tablet: Trapezoid writing tablet. [08]

Writing Tablet Support: Available in Chrome as an upcharge.

Power: Power is available on Boundary-08.

Product Certification

Intertek Sustainability Clean Air Product Certification

Clean Air certification provides proof that products have been independently tested and found to conform to VOC standards and to the ANSI/ BIFMA Furniture Emissions Standards. All Orangebox products* have achieved Gold certification, excluding laminate products which achieve a Silver certification.

*With the exception of Fielding Tables.

BS EN 15373:2007

Test Level 2 - Strength durability and Safety.

Product Finish Options

Boundary - Shape & Legs

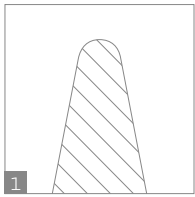

1. Back Shape
2. Landscape Leg

Boundary - 08 options

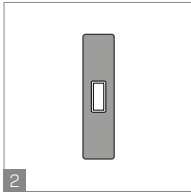
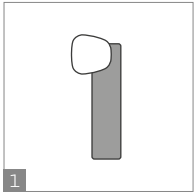

1. You can specify up to 2 tablets per unit.
2. Power / Data

Fabric Selection

Two Tone Upholstery

When selecting this option the two fabrics should be from the same family. Seat and back can be different fabrics or leathers.

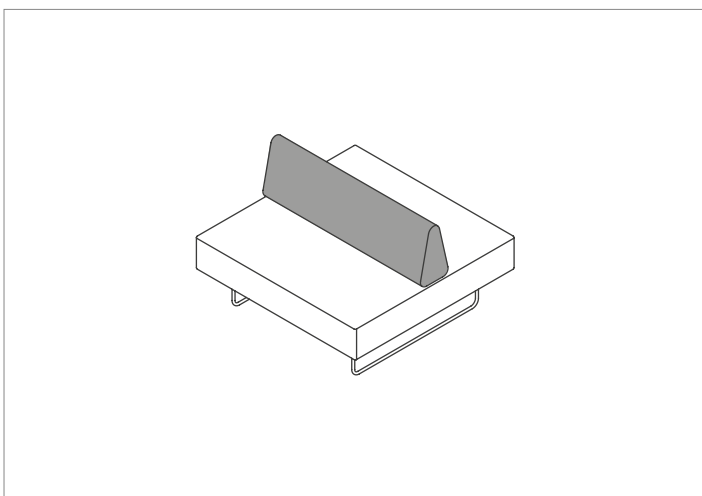

Product Finishes

Tubular Legs



RAL 9006



Stone



Black



White



Chrome

Landscape Legs



RAL 9006



Stone



Black



White



Chrome

Writing Table Support



RAL 9006



Stone



Chrome

Table Tops — Melamine

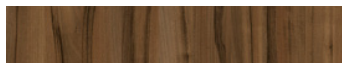

Walnut



Grained Oak



Artisan Oak



Beech

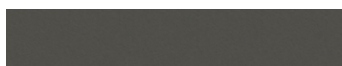

Graphite

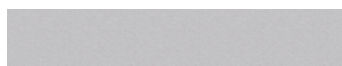

Grey



White